

Notes/Instructions:

| REV | REV DATE | DESCRIPTION | APPROVAL |
|-----|------------|-------------|----------|
| A | 2020-04-09 | RELEASE | SD/RF |

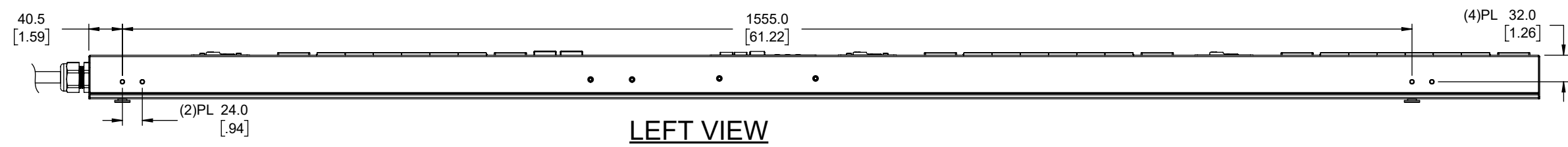

LEFT VIEW

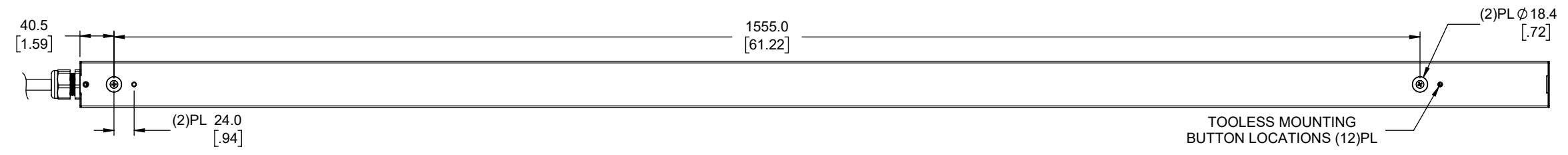

REAR VIEW

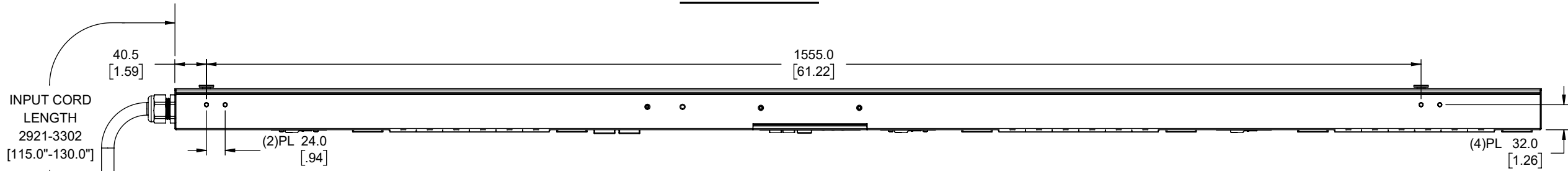

RIGHT VIEW

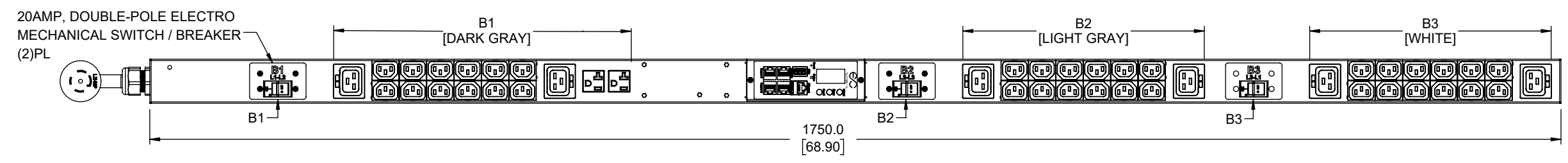

FRONT VIEW

BOTTOM VIEW

PLUG/RECEPTACLE BLOCK

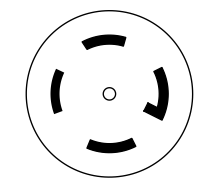

PLUG
NEMA L21-30P, 4P 5W
30A, 250V, MAX RATED INPUT
24A DERATED

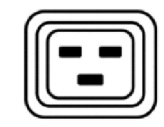

RECEPTACLES
IEC 60320/C19
16A, 250V MAX RATED OUTPUT



RECEPTACLES
IEC 60320/C13
10A, 250V MAX RATED OUTPUT

UNIT TYPE: INPUT METERED
ORIENTATION: VERTICAL, 0U FULL
OUTLET QTY & TYPE: (36)C13, (6)C19, (2)5-20R
INPUT VOLTAGE: 208VAC
INPUT CURRENT: 30A (24A DERATED)
BREAKER QTY & TYPE: (2) 20AMP, DOUBLE-POLE
INPUT PHASE: THREE-PHASE
RATED POWER: 8.6 kVA
INPUT PLUG: NEMA L21-30P
INPUT POWER CORD: 3m [10'], BOTTOM FEED
REGULATORY STANDARD: RoHS COMPLIANT

Notes:
This drawing and its specifications are the property of ENCONNEX and shall not be copied, reproduced, or used in whole or in part, as the basis for the manufacture or sale of items without written permission from ENCONNEX. This drawing is based upon the latest available information and is subject to change without notice.

| | | | |
|---|---|--|---|
| TOLERANCES LINEAR (mm) X = ± 1 X.X = ± 0.5 X.XX = ± 0.30 X.XXX = ± 0.130 ANGULAR X = 1° .X = 0.5° .XX = 0.25° | MATERIAL: | | PART NUMBER: ECX-MV1736060-G |
| | DESCRIPTION: | | DESCRIPTION: 4670 AIRCENTER CIRCLE, RENO, NV 89502 |
| | DEBUR AND BREAK SHARP EDGES/CORNERS AT 0.2mm MAX | DRAWN BY: WADE A. CLARKE APPROVED BY: R. FAULKNER | ORG DATE: 2020-04-09 REV DATE: |
| UNITS: mm [in] | INTERPRET TO ASME Y14.100 | SIZE: B SCALE: 1 : 1 | SHEET: 1/2 REV: A |

Notes/Instructions:

| REV | REV DATE | DESCRIPTION | APPROVAL |
|-----|------------|-------------|----------|
| A | 2020-04-09 | RELEASE | SD/RF |

Input Cable Type: SJT; 90°C; 300V; 10AWG; 5C

Internal Wire Type: UL AWM 1015, 105°C, 12/18AWG

- 1: Line1/R/X Wire Color = Black
- 2: Line2/S/Y Wire Color = Orange
- 3: Line3/T/Z Wire Color = Red
- 4: Neutral Wire Color = White
- 5: Earth ground Wire Color = Green/Yellow (Stripe)

Input main Ground Terminal and CB Terminal: KST,RNYD5-5
 Outlet Ground Terminal: KST,RNYDL5-4
 Internal Wire to Outlet Terminal: Molex,0192160009

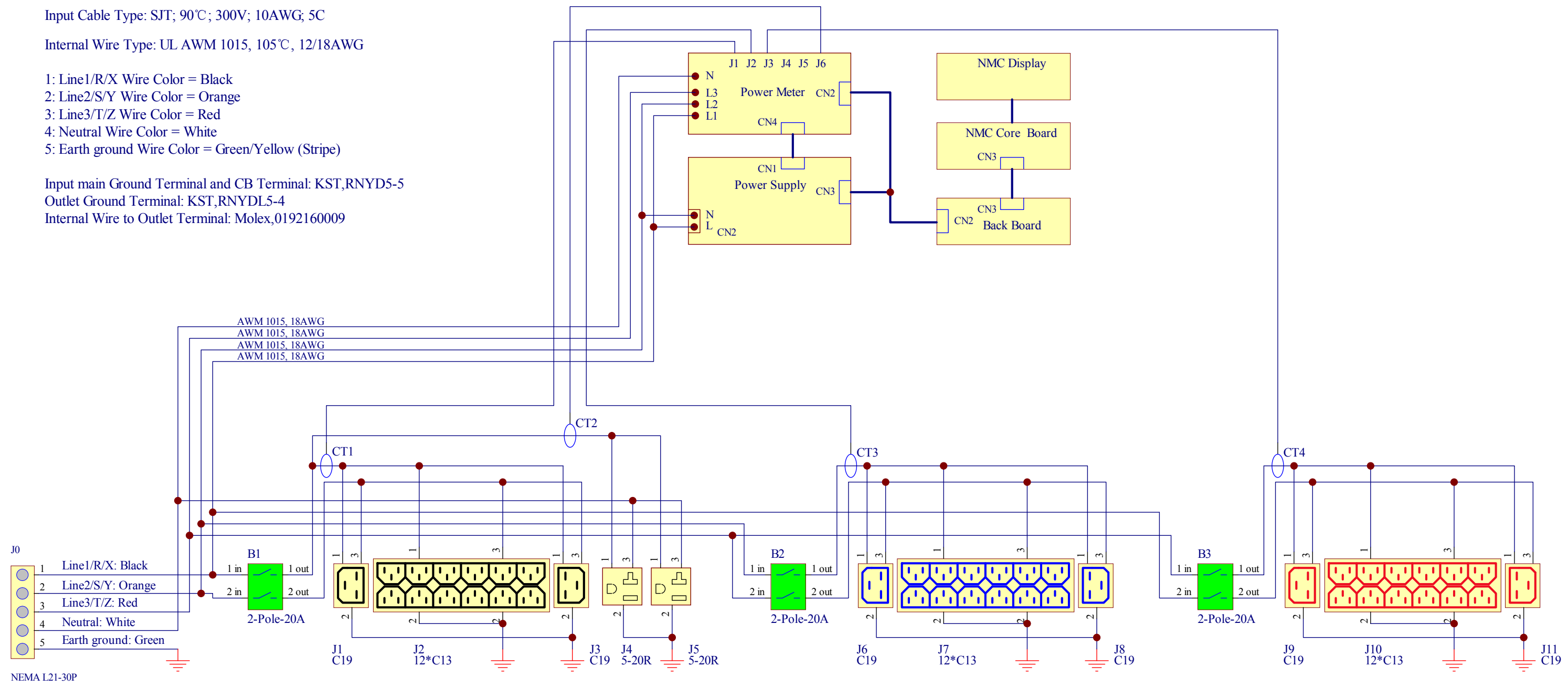

Notes:
 This drawing and its specifications are the property of ENCONNEX and shall not be copied, reproduced, or used in whole or in part, as the basis for the manufacture or sale of items without written permission from ENCONNEX. This drawing is based upon the latest available information and is subject to change without notice.

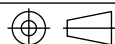
| | | | |
|---|--|--|---------------------------------|
| TOLERANCES LINEAR (mm) X = ± 1 X.X = ± 0.5 X.XX = ± 0.30 X.XXX = ± 0.130 ANGULAR X = 1° .X = 0.5° .XX = 0.25° | MATERIAL: |  ENCONNEX 4670 AIRCENTER CIRCLE, RENO, NV 89502 | PART NUMBER: ECX-MV1736060-G |
| | DESCRIPTION: | | DESCRIPTION: |
|  DEBUR AND BREAK SHARP EDGES/CORNERS AT 0.2mm MAX | DRAWN BY: WADE A. CLARKE APPROVED BY: R. FAULKNER | ORG DATE: 2020-04-09 REV DATE: | SHEET: 2/2 REV: A |
| UNITS: mm [in] | INTERPRET TO ASME Y14.100 | SIZE: B | SCALE: 1 : 1 |