

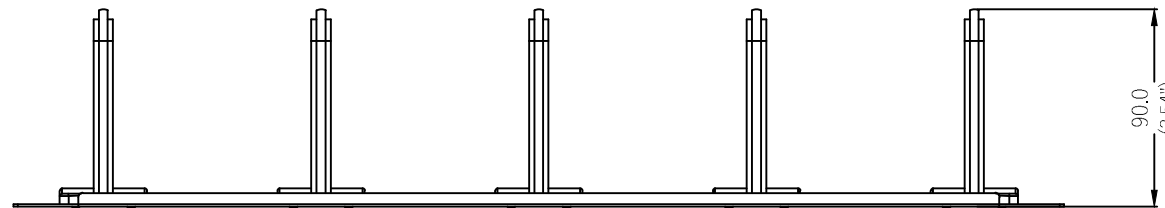

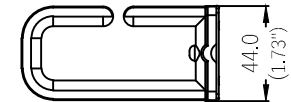

Notes/Instructions:

REV	REV DATE	DESCRIPTION	APPROVAL
A	2019-03-25	RELEASE	SD/RF

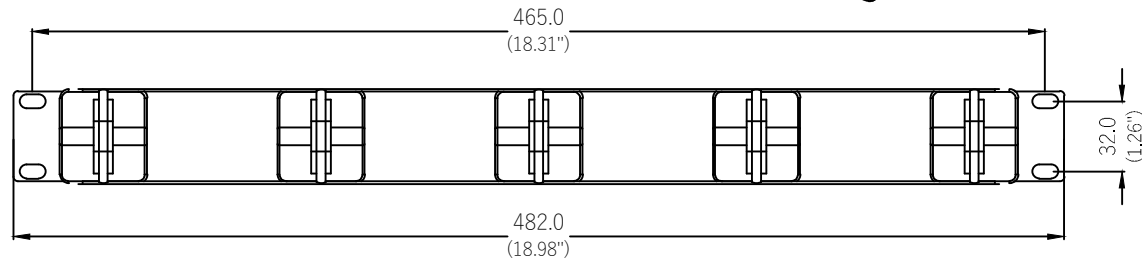
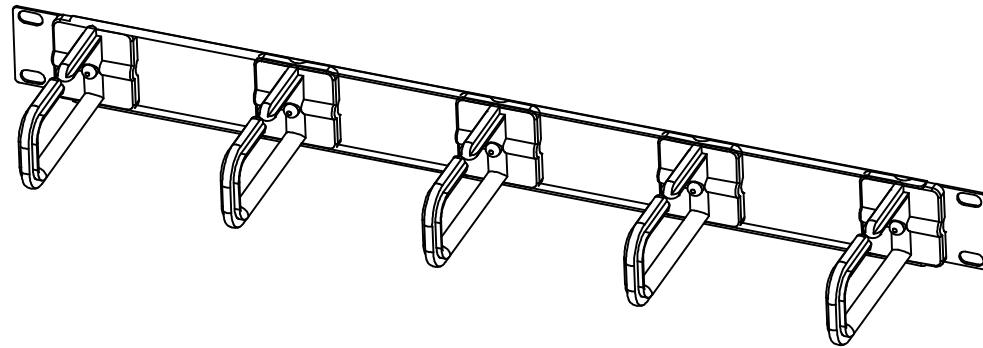

Notes:

This drawing and its specifications are the property of ENCONNEX and shall not be copied, reproduced, or used in whole or in part, as the basis for the manufacture or sale of items without written permission from ENCONNEX. This drawing is based upon the latest available information and is subject to change without notice.

TOLERANCES LINEAR (mm) X = ± 1 X.X = ± 0.5 X.XX = ± 0.30 X.XXX = ± 0.130 ANGULAR X = 1° .X = 0.5° .XX = 0.25°	MATERIAL: VARIOUS	 4670 AIRCENTER CIRCLE, RENO, NV 89502	PART NUMBER: ECX-CBLMGR-HZ-5R-1U
	FINISH:		DESCRIPTION: Enconnex 19", 5 ring horizontal cable management panel, 1U
  DEBUR AND BREAK SHARP EDGES/CORNERS AT 0.2mm MAX	DRAWN BY: SAM DING	ORG DATE: 2019-03-25	
 UNITS: mm [in]	INTERPRET TO ASME Y14.100	APPROVED BY: R. FAULKNER	REV DATE: 2019-03-25
	SIZE: A4	SCALE: N/A	SHEET: 1/1
			REV: A