

LOCKING LATCHES

Single front mesh door

Split rear mesh doors

Front Door

Rear Doors

Keys
(for doors and side panels)

Notes:
This drawing and specifications are the property of ENCONNEX and shall not be copied, reproduced or used in whole or in part, as the basis for the manufacture or sale of items without written permission from ENCONNEX. This drawing is the based upon latest available information and is subject to change without notice.

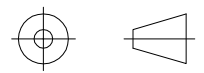

TITLE:
SERVER RACK
600mm W X 1100mm D
X 42U

ECX NO:
ECX-61142-C3

DRAWN BY: AMY ZHU

MATERIAL: -----
DATE: 2018-12-27

APPROVED BY: SAM DING

REV DATE: 2018-12-27

UNIT: mm & IN

SCALE: 1:1

PAGE: 1/5

REV: A

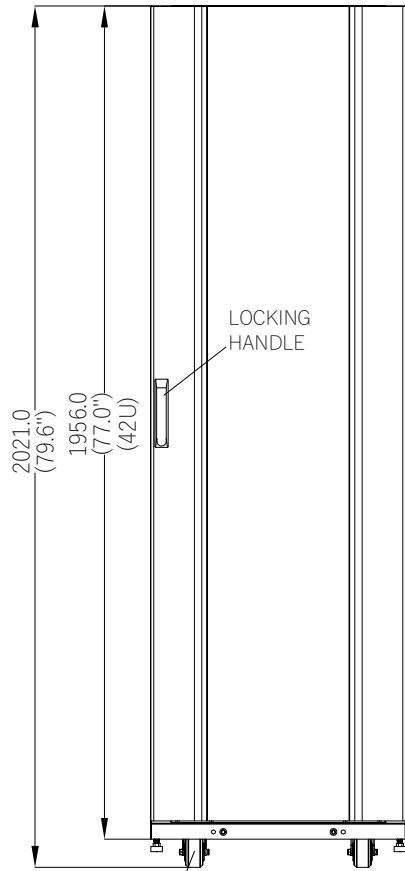

Front View

3" Heavy Duty Casters

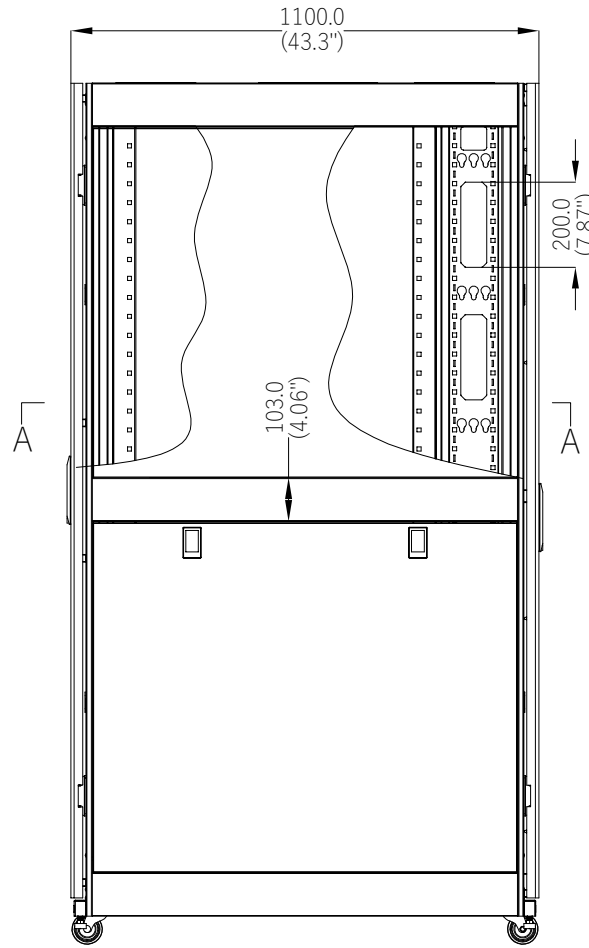

Side View

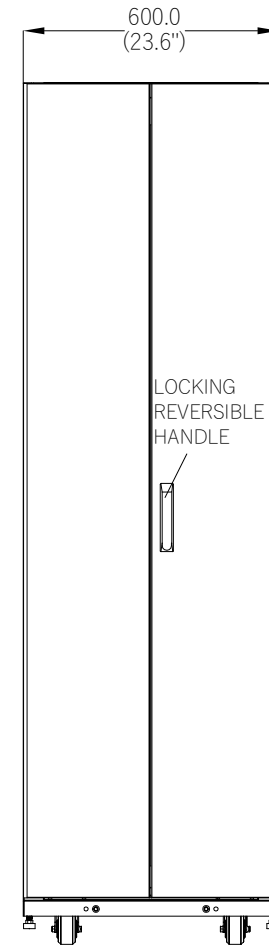

Rear View

Notes:

This drawing and specifications are the property of ENCONNEX and shall not be copied, reproduced or used in whole or in part, as the basis for the manufacture or sale of items without written permission from ENCONNEX. This drawing is based upon latest available information and is subject to change without notice.

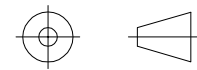

TITLE:
SERVER RACK
600mm W X 1100mm D
X 42U

ECX NO:
ECX-61142-C3

DRAWN BY: AMY ZHU

MATERIAL: -----

APPROVED BY: SAM DING

DATE: 2018-12-27

UNIT: mm & IN

SCALE: 1 : 1

PAGE: 2/5

REV: A

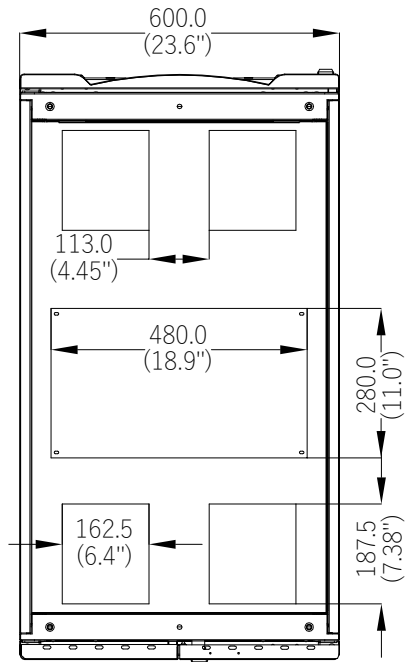

Top View

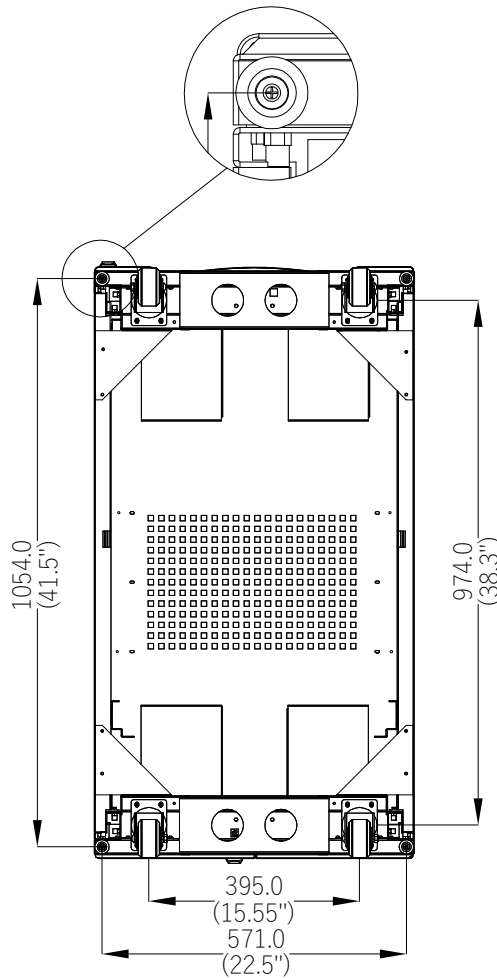

Bottom View

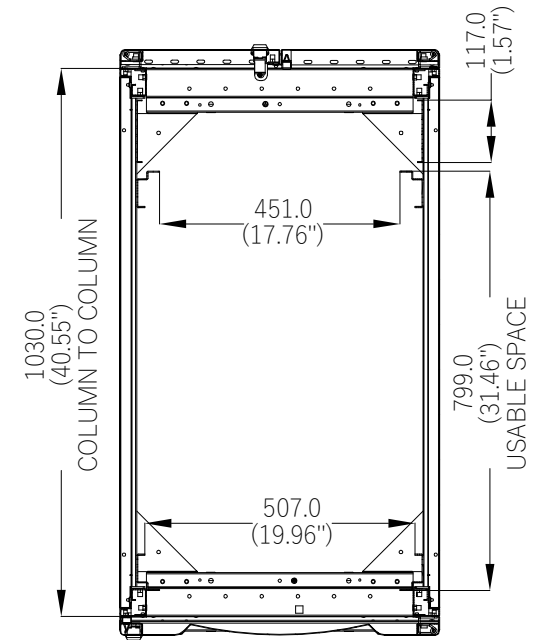

A-A
Profile View

Notes:

This drawing and specifications are the property of ENCONNEX and shall not be copied, reproduced or used in whole or in part, as the basis for the manufacture or sale of items without written permission from ENCONNEX. This drawing is based upon latest available information and is subject to change without notice.

		TITLE: SERVER RACK 600mm W X 1100mm D X 42U	ECX NO: ECX-61142-C3
	DRAWN BY: AMY ZHU	DATE: 2018-12-27	MATERIAL: -----
APPROVED BY: SAM DING	REV DATE: 2018-12-27	UNIT: mm & IN	SCALE: 1:1
PAGE: 3/5	REV: A		

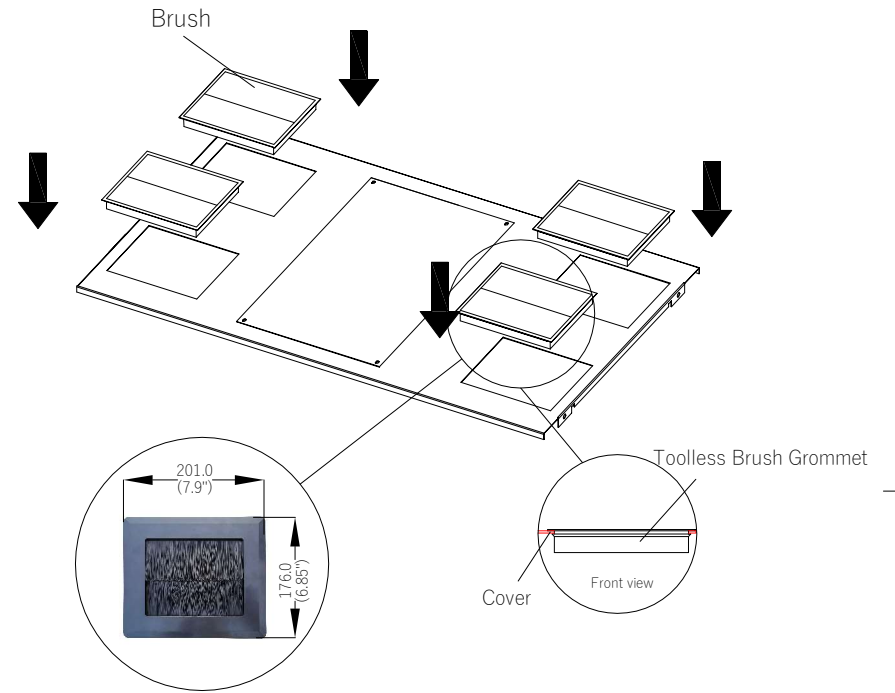
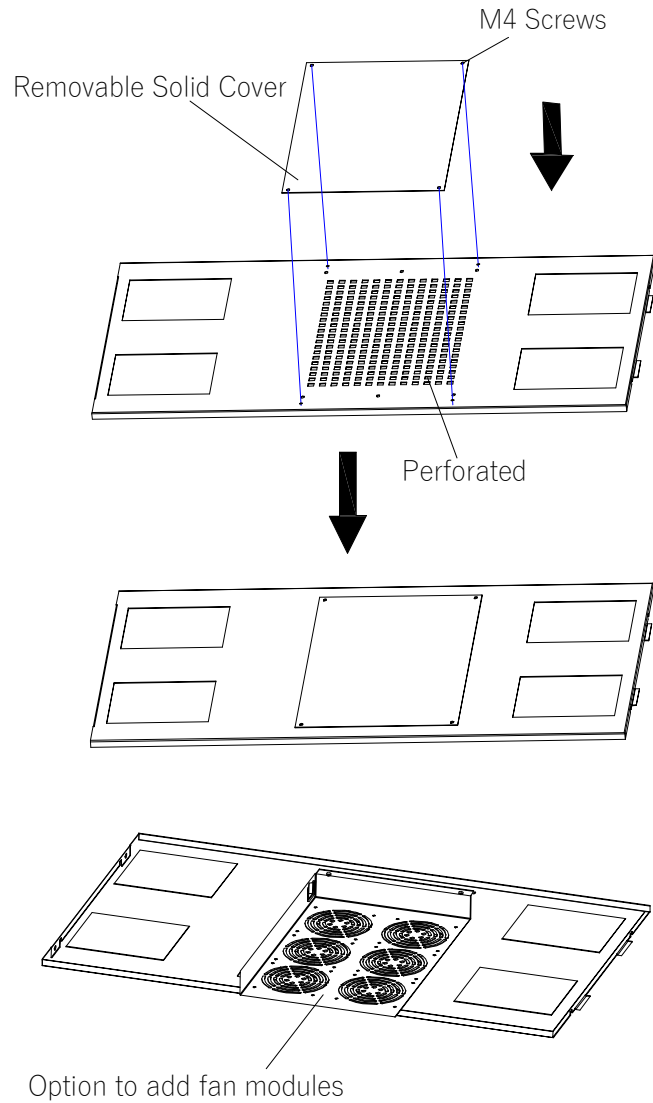

Notes:
 This drawing and specifications are the property of ENCONNEX and shall not be copied, reproduced or used in whole or in part, as the basis for the manufacture or sale of items without written permission from ENCONNEX. This drawing is based upon latest available information and is subject to change without notice.

	TITLE:	ECX NO:
	ROOF	ECX-ROOF-611-04
DRAWN BY:	AMY ZHU	DATE: 2018-12-17
APPROVED BY:	SAM DING	REV DATE: 2018-12-17
UNIT: mm & IN	SCALE: 1:1	PAGE: 4/5
		REV: A

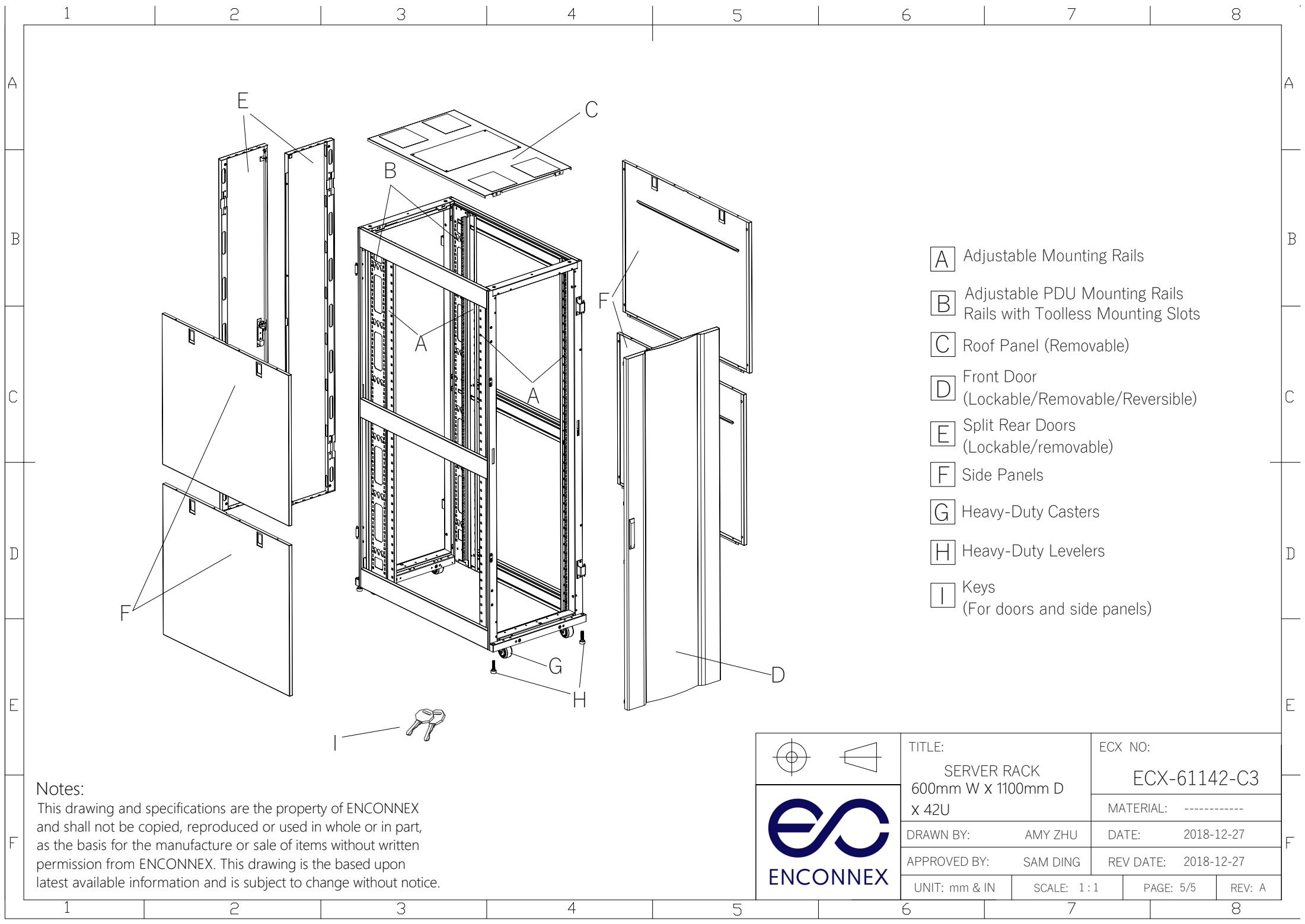

- A** Adjustable Mounting Rails
- B** Adjustable PDU Mounting Rails
Rails with Toolless Mounting Slots
- C** Roof Panel (Removable)
- D** Front Door
(Lockable/Removable/Reversible)
- E** Split Rear Doors
(Lockable/removable)
- F** Side Panels
- G** Heavy-Duty Casters
- H** Heavy-Duty Levelers
- I** Keys
(For doors and side panels)

Notes:
 This drawing and specifications are the property of ENCONNEX and shall not be copied, reproduced or used in whole or in part, as the basis for the manufacture or sale of items without written permission from ENCONNEX. This drawing is the based upon latest available information and is subject to change without notice.

	TITLE: SERVER RACK 600mm W X 1100mm D X 42U	ECX NO: ECX-61142-C3
	DRAWN BY: AMY ZHU	DATE: 2018-12-27
APPROVED BY: SAM DING	REV DATE: 2018-12-27	MATERIAL: -----
UNIT: mm & IN	SCALE: 1 : 1	PAGE: 5/5
		REV: A