

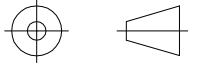

Notes:

This drawing and specifications are the property of ENCONNEX and shall be not copied, reproduced or used in whole or in part, as the basis for the manufacture or sale of items without written permission from ENCONNEX. This drawing is the based upon latest available information and is subject to change without notice.

		TITLE: SERVER RACK 600mm W X 1000mm D X 52U	ECX NO: ECX-61052-C3
	DRAWN BY: AMY ZHU		DATE: 2018-12-27
APPROVED BY: SAM DING		REV DATE: 2018-12-27	
UNIT: mm & IN	SCALE: 1 : 1	PAGE: 1/5	REV: A

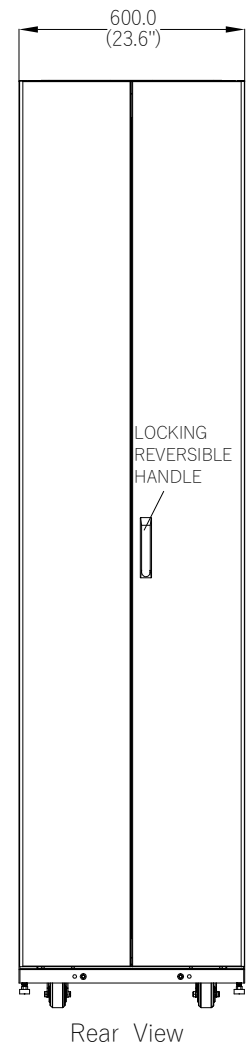
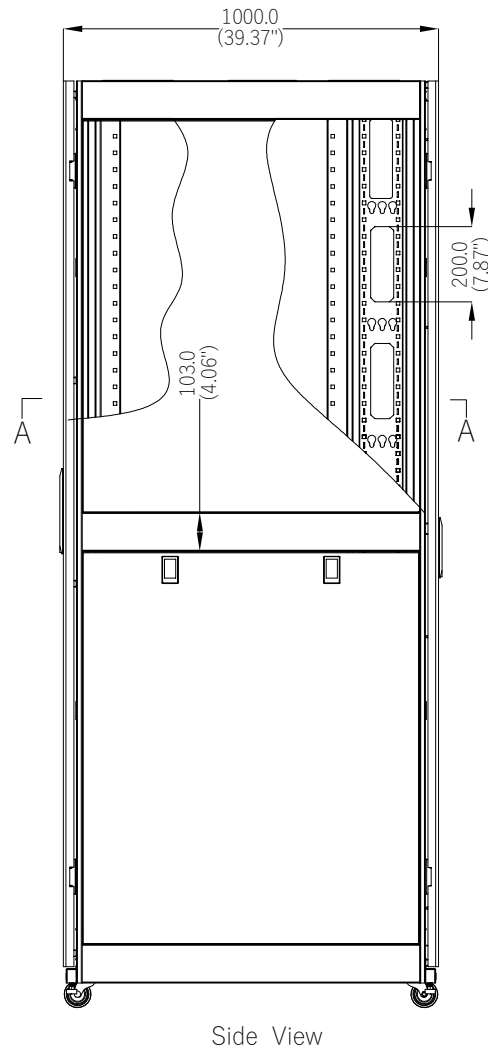
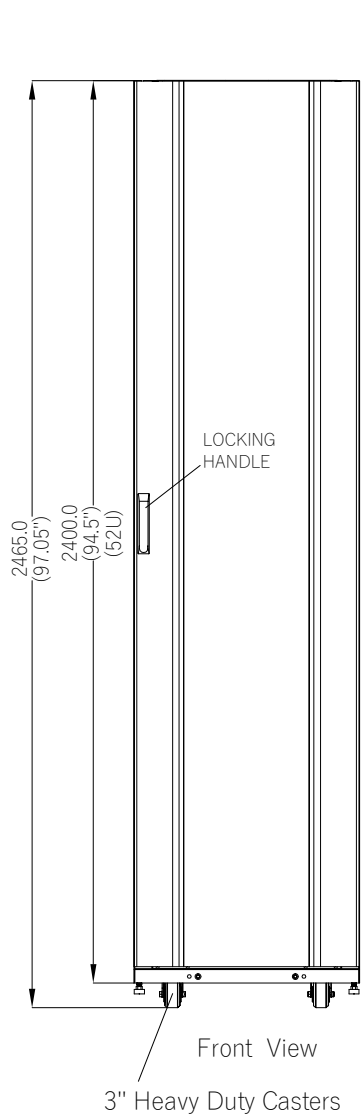

Notes:
This drawing and specifications are the property of ENCONNEX and shall be not copied, reproduced or used in whole or in part, as the basis for the manufacture or sale of items without written permission from ENCONNEX. This drawing is the based upon latest available information and is subject to change without notice.

	TITLE: SERVER RACK 600mm W X 1000mm D X 52U	ECX NO: ECX-61052-C3
	DRAWN BY: AMY ZHU APPROVED BY: SAM DING	MATERIAL: ----- DATE: 2018-12-27 REV DATE: 2018-12-27
UNIT: mm & IN SCALE: 1 : 1	PAGE: 2/5	REV: A

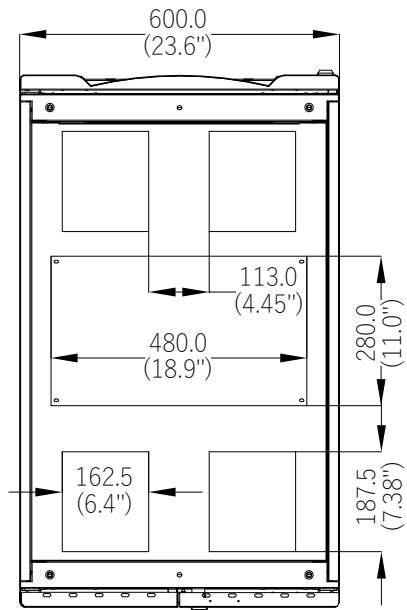

Top View

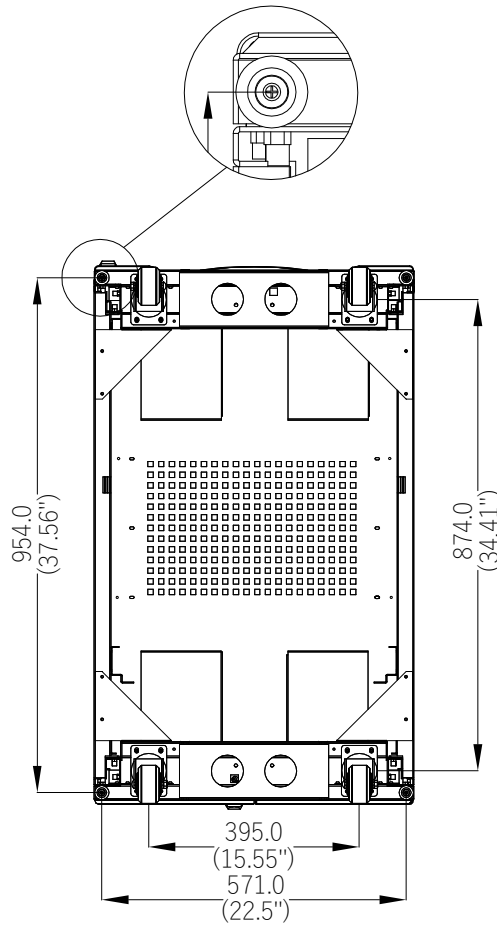

Bottom View

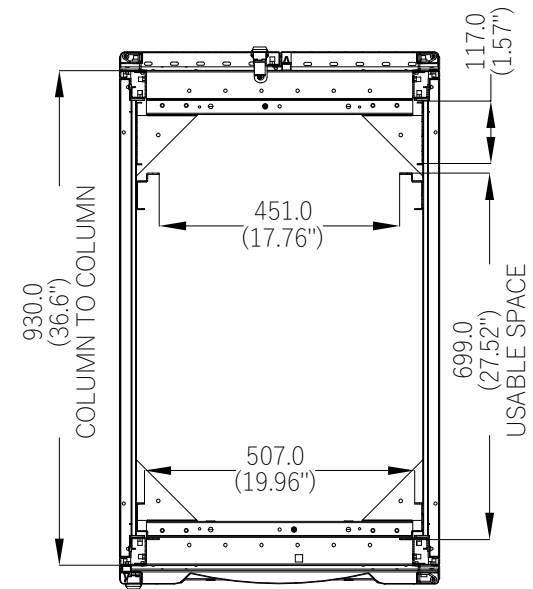

A-A
Profile View

Notes:

This drawing and specifications are the property of ENCONNEX and shall be not copied, reproduced or used in whole or in part, as the basis for the manufacture or sale of items without written permission from ENCONNEX. This drawing is the based upon latest available information and is subject to change without notice.

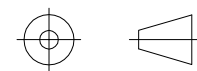

TITLE:
SERVER RACK
600mm W X 1000mm D
X 52U

ECX NO:
ECX-61052-C3

DRAWN BY: AMY ZHU

MATERIAL: -----

APPROVED BY: SAM DING

DATE: 2018-12-27

REV DATE: 2018-12-27

UNIT: mm & IN

SCALE: 1 : 1

PAGE: 3/5

REV: A

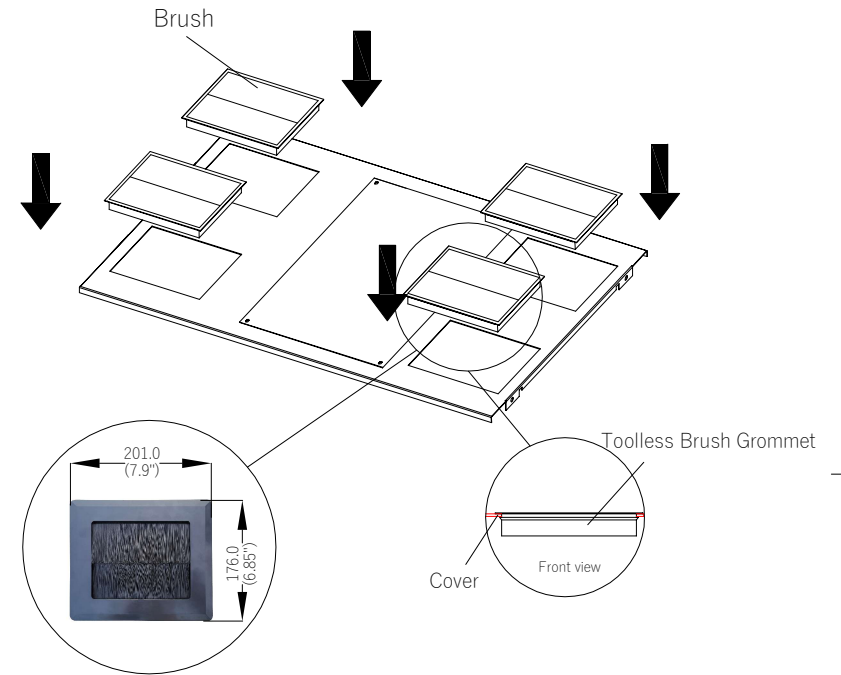
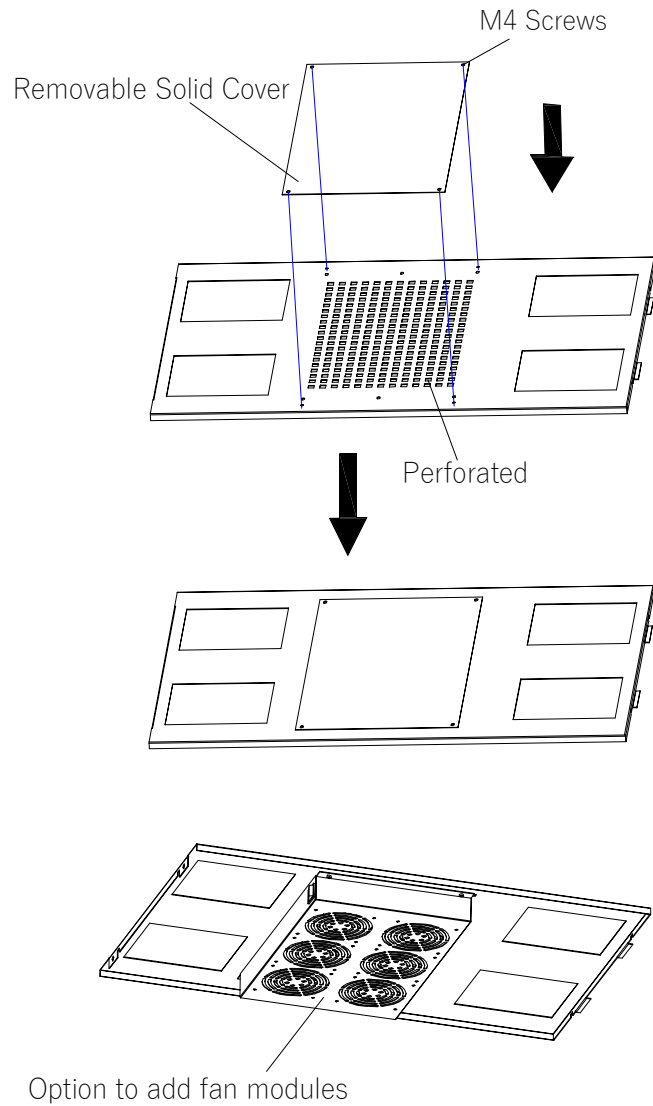

Notes:
 This drawing and specifications are the property of ENCONNEX and shall be not copied, reproduced or used in whole or in part, as the basis for the manufacture or sale of items without written permission from ENCONNEX. This drawing is the based upon latest available information and is subject to change without notice.

		TITLE:	ECX NO:
	ROOF	ECX-ROOF-610-04	
		DRAWN BY: AMY ZHU	DATE: 2018-12-17
		APPROVED BY: SAM DING	REV DATE: 2018-12-17
		UNIT: mm & IN	SCALE: 1:1
		PAGE: 4/5	REV: A

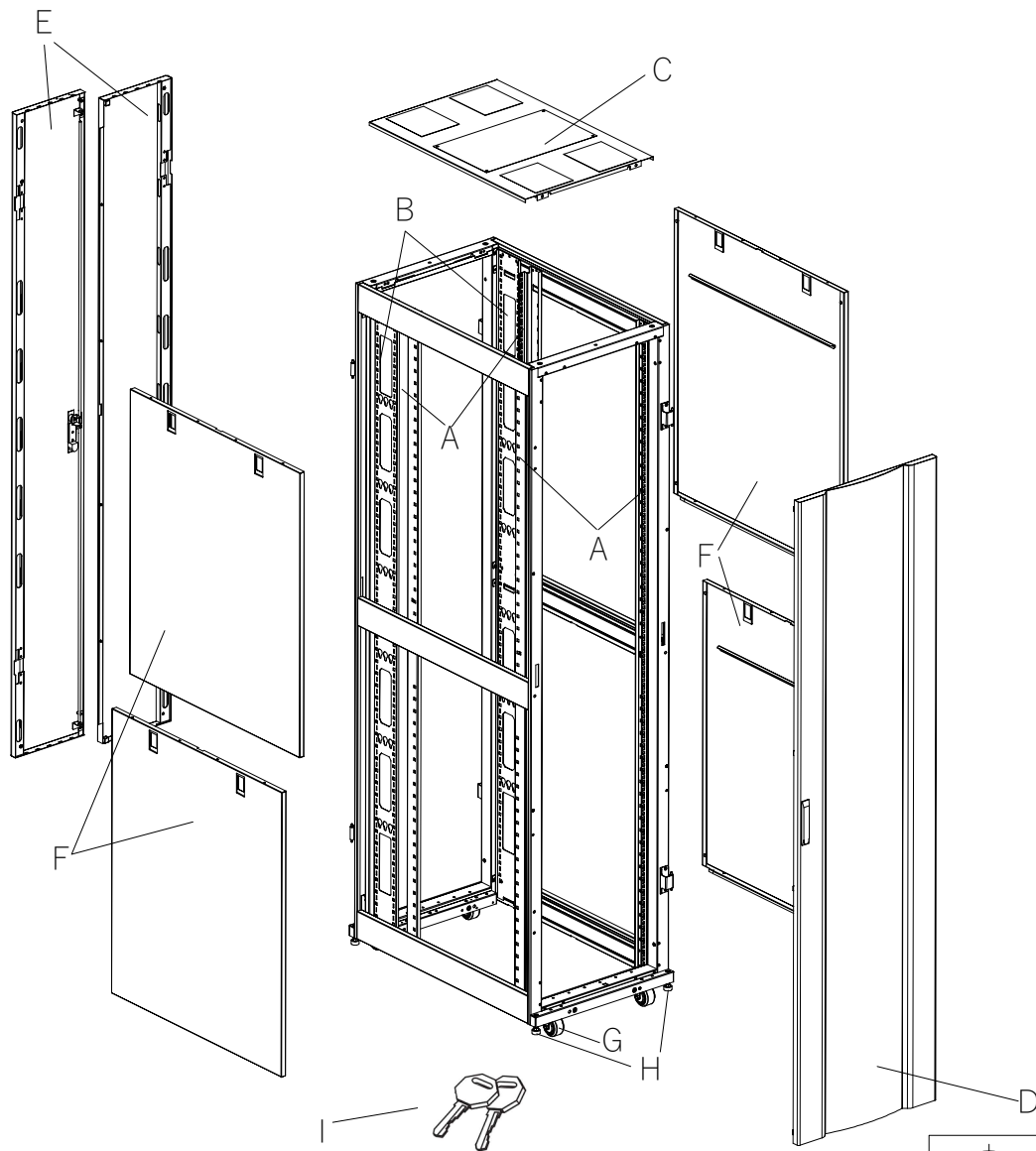

- A** Adjustable Mounting Rails
- B** Adjustable PDU Mounting Rails
Rails with Toolless Mounting Slots
- C** Roof Panel (Removable)
- D** Front Door
(Lockable/Removable/Reversible)
- E** Split Rear Doors
(Lockable/removable)
- F** Side Panels
- G** Heavy-Duty Casters
- H** Heavy-Duty Levels
- I** Keys
(For doors and side panels)

Notes:

This drawing and specifications are the property of ENCONNEX and shall be not copied, reproduced or used in whole or in part, as the basis for the manufacture or sale of items without written permission from ENCONNEX. This drawing is the based upon latest available information and is subject to change without notice.

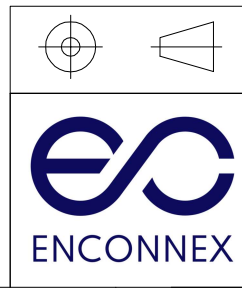

		TITLE: SERVER RACK 600mm W X 1000mm D X 52U		ECX NO: ECX-61052-C3	
				MATERIAL: -----	
DRAWN BY: AMY ZHU		DATE: 2018-12-27			
APPROVED BY: SAM DING		REV DATE: 2018-12-27			
UNIT: mm & IN		SCALE: 1:1		PAGE: 5/5	
				REV: A	