

Notes/Instructions:

REV	REV DATE	DESCRIPTION	APPROVAL
A	2021-02-17	RELEASE	SD/RF

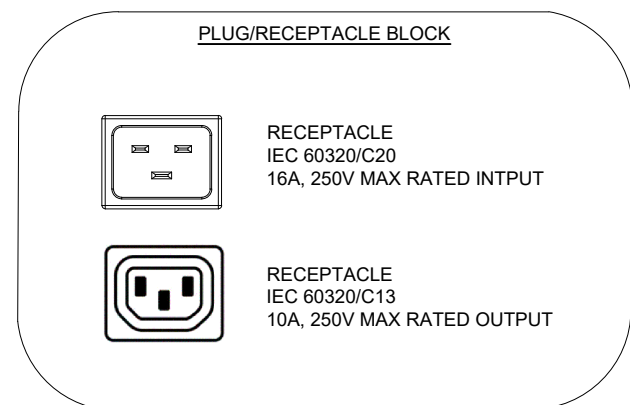
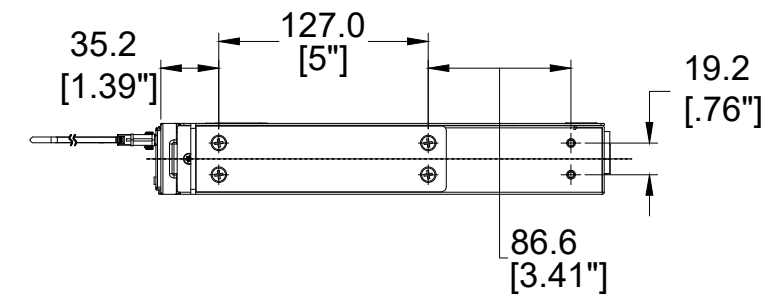
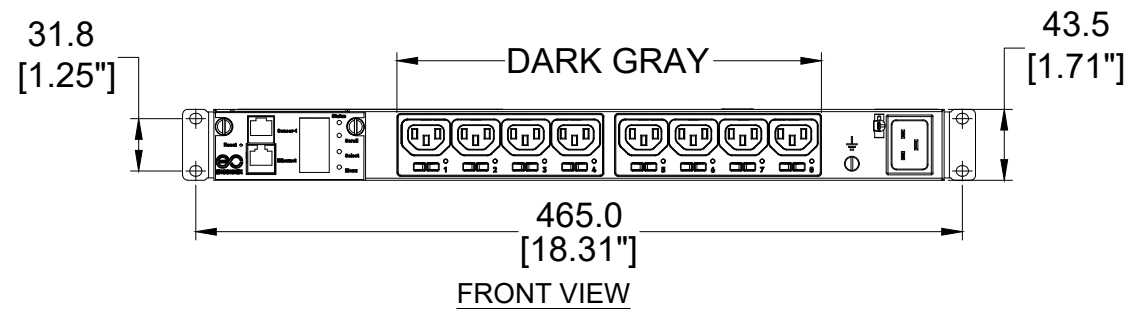
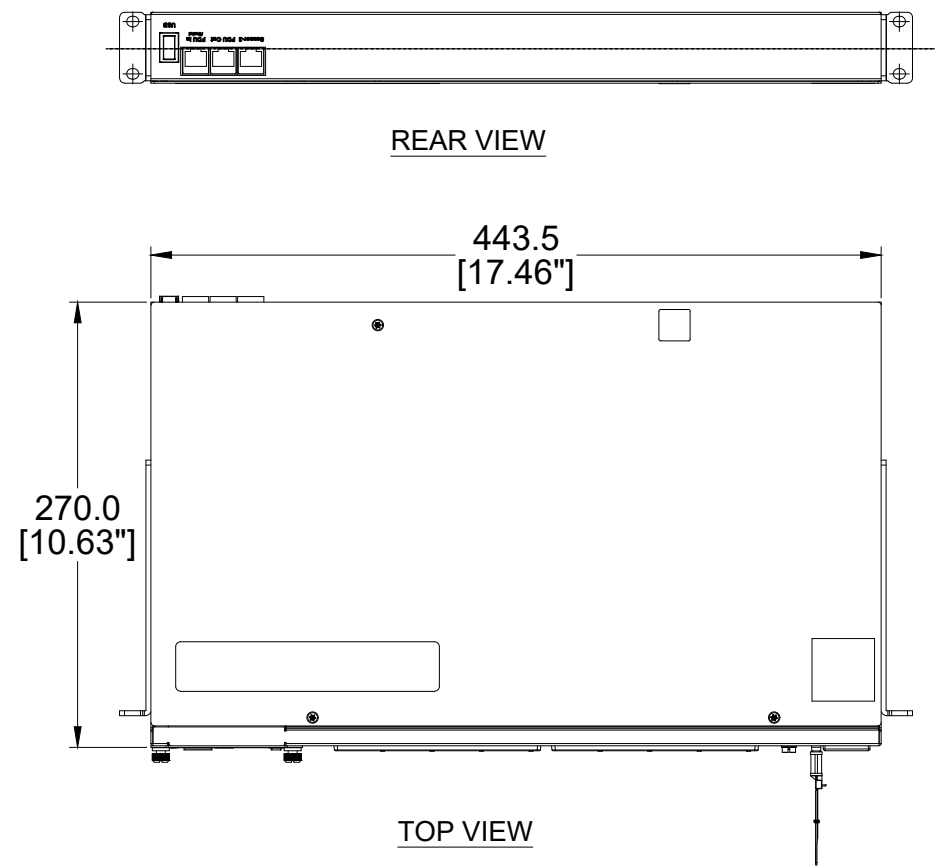

SPECIFICATION:

- | | |
|--------------|-------------------------------------|
| 1. STANDARD: | UNIT TYPE: MONITORED SWITCHED |
| | ORIENTATION: HORIZONTAL, 1U |
| | OUTLET QTY & TYPE: (8) C13 |
| | INPUT VOLTAGE: 100-240VAC |
| | INPUT CURRENT: 20A(NAM) / 16A(EU) |
| | BREAKER QTY & TYPE: N/A |
| | INPUT PHASE: SINGLE-PHASE |
| | RATED POWER: 3.7kVA DUAL RATED |
| | INPUT PLUG: IEC 60320 C20 |
| | INPUT POWER CORD: N/A |
| | REGULATORY STANDARD: RoHS COMPLIANT |

2. ADDITIONAL:
NONE
3. ACCESSORIES:
(1)QUICK-START GUIDE

Notes:

This drawing and its specifications are the property of ENCONNEX and shall not be copied, reproduced, or used in whole or in part, as the basis for the manufacture or sale of items without written permission from ENCONNEX. This drawing is based upon the latest available information and is subject to change without notice.

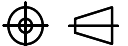
TOLERANCES LINEAR (mm) X = ± 1 X.X = ± 0.5 X.XX = ± 0.30 X.XXX = ± 0.130 ANGULAR X = 1° .X = 0.5° .XX = 0.25°	MATERIAL:	 4670 AIRCENTER CIRCLE, RENO, NV 89502	PART NUMBER: ECX-SH1108000-A		
	DESCRIPTION:		DESCRIPTION:		
 DEBUR AND BREAK SHARP EDGES/CORNERS AT 0.2mm MAX	DRAWN BY: LJB	ORG DATE: 2021-02-17			
	APPROVED BY: Hanson Xu	REV DATE:			
UNITS: mm [in]	INTERPRET TO ASME Y14.100	SIZE: A3	SCALE: 1 : 1	SHEET: 1/2	REV: A

Notes/Instructions:

REV	REV DATE	DESCRIPTION	APPROVAL
A	2021-02-17	RELEASE	SD/RF

NOTES:

1. INTERNAL WIRING:

WIRE TYPE: UL AWM 1015, 12 & 18AWG
 LINE 1/R/X COLOR: BROWN
 EARTH GROUND COLOR: GREEN/YELLOW STRIPE
 NEUTRAL WIRE COLOR: BLUE

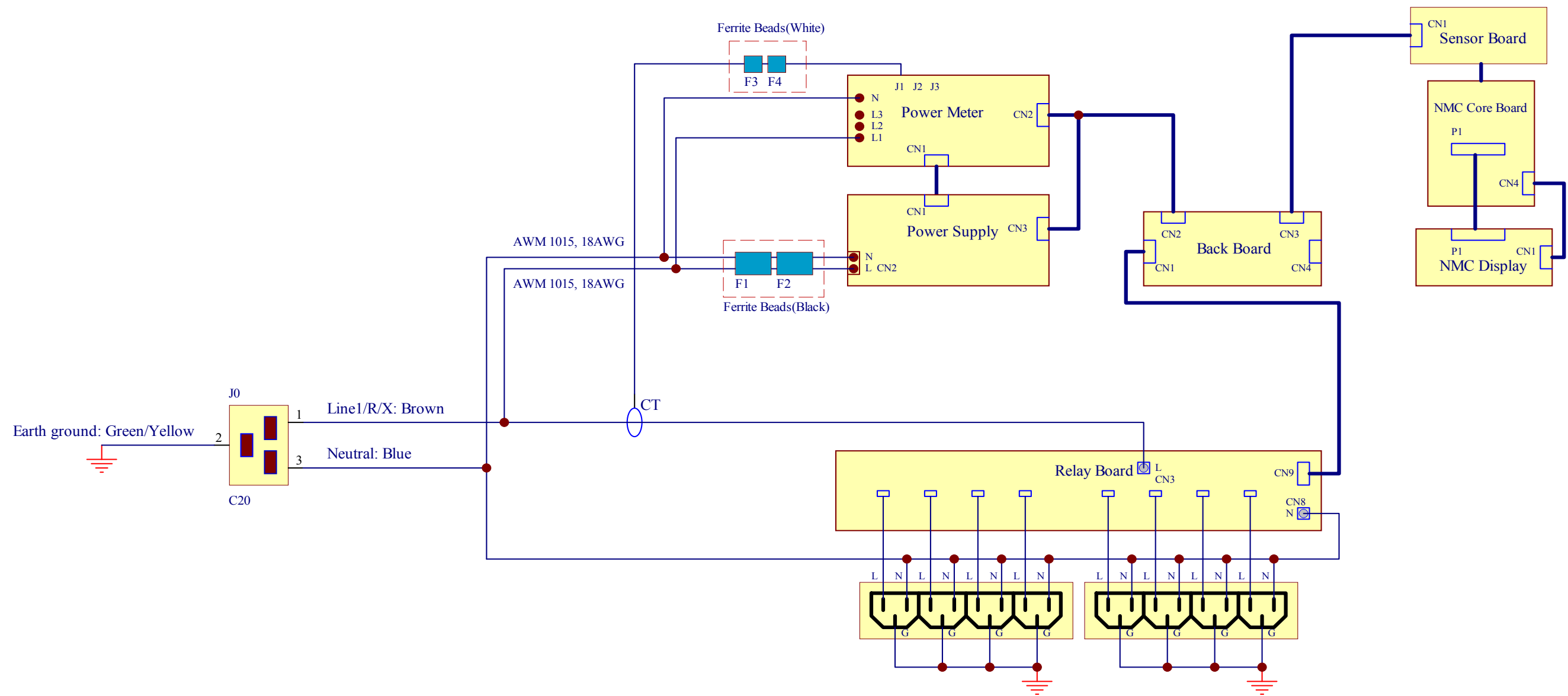

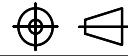
TOLERANCES LINEAR (mm) X = ± 1 X.X = ± 0.5 X.XX = ± 0.30 X.XXX = ± 0.130 ANGULAR X = 1° .X = 0.5° .XX = 0.25°	MATERIAL:	 4670 AIRCENTER CIRCLE, RENO, NV 89502	PART NUMBER: ECX-SH1108000-A	
	DESCRIPTION:		DESCRIPTION:	
 DEBUR AND BREAK SHARP EDGES/CORNERS AT 0.2mm MAX	DRAWN BY: LJB	ORG DATE: 2021-02-17		
UNITS: mm [in]	INTERPRET TO ASME Y14.100	APPROVED BY: Hanson Xu	REV DATE:	
	SIZE: A3	SCALE: 1 : 1	SHEET: 2/2	REV: A