

Notes/Instructions:

1. MATERIAL: N/A
2. FINISH: N/A
3. PART MUST BE SUFFICIENTLY FREE OF BURRS AND SHARP EDGES TO PASS UL 1439 SHARP EDGE TEST.
4. MARK ENCONNEX PART # AND VENDOR I.D. 3MM HIGH WHERE SHOWN. IF PART TOO SMALL BAG OR TAG WITH SAME INFORMATION.
5. 3D CAD AVAILABLE IN ADDITION TO PDF PRINT. SHOULD DISCREPANCY ARISE, CONSULT ENCONNEX ENGINEERING IMMEDIATELY.
6. ALL PARTS TO BE FREE OF DIRT OR GRIME THAT PREVENTS LABEL ADHESION OR ALLOWS TRANSFER ONTO COSMETIC AREAS.
7. MUST BE ROHS COMPLIANT, INCLUDING HARDWARE. IF CONFLICTING SPECIFICATIONS EXIST, CONTACT ENCONNEX ENGINEERING.
8. MARK ENCONNEX PART # AND VENDOR I.D. 3MM HIGH WHERE SHOWN. IF PART TOO SMALL BAG OR TAG WITH SAME INFORMATION.
9. DIMENSIONS IDENTIFIED WITH (XXX) ARE CONSIDERED CRITICAL TO QUALITY (CTQ) DIMENSIONS. THESE DIMENSIONS ARE EXPECTED TO BE MONITORED STATISTICALLY AND DOCUMENTED AS PART OF THE FABRICATION PROCESS.

REV	REV DATE	DESCRIPTION	APPROVAL
-	-	-	-

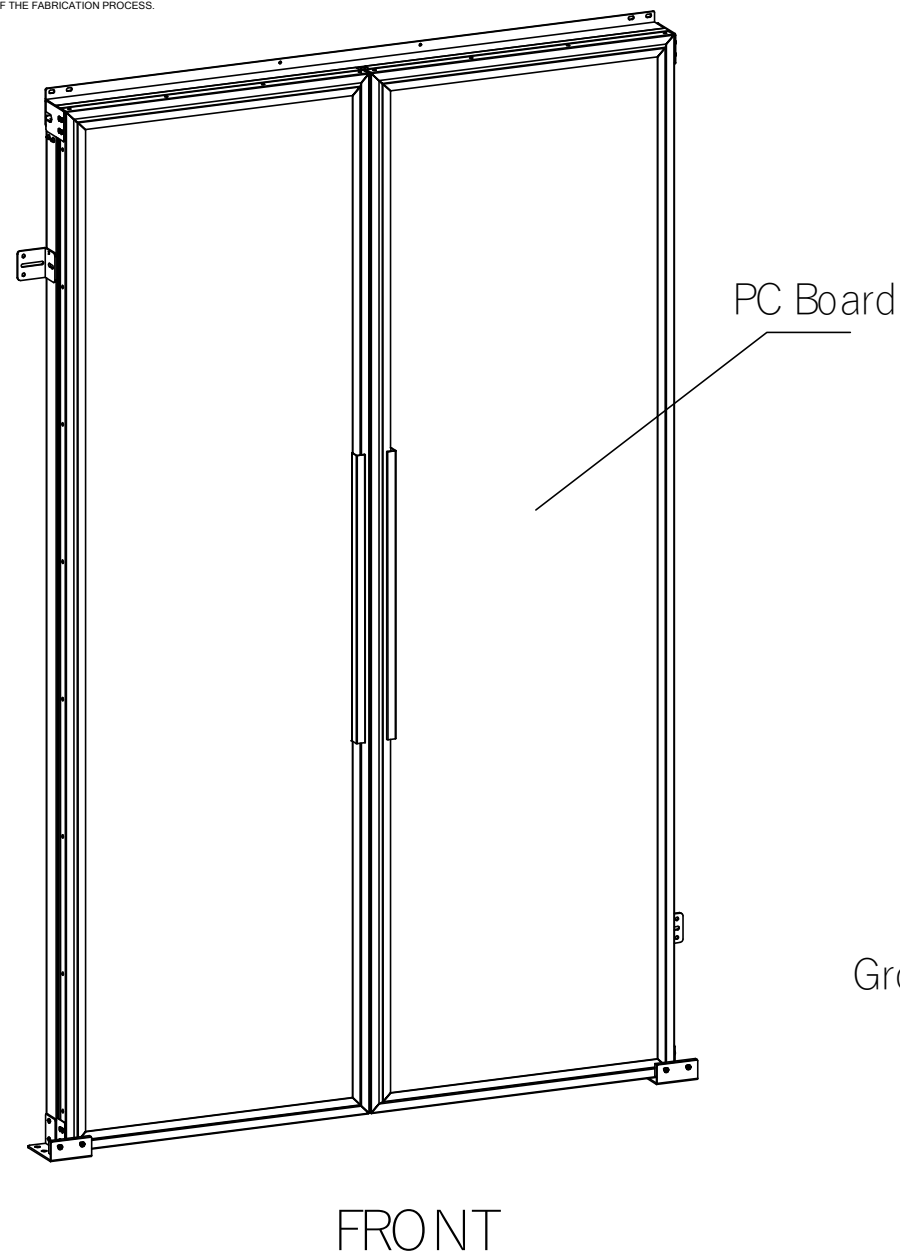

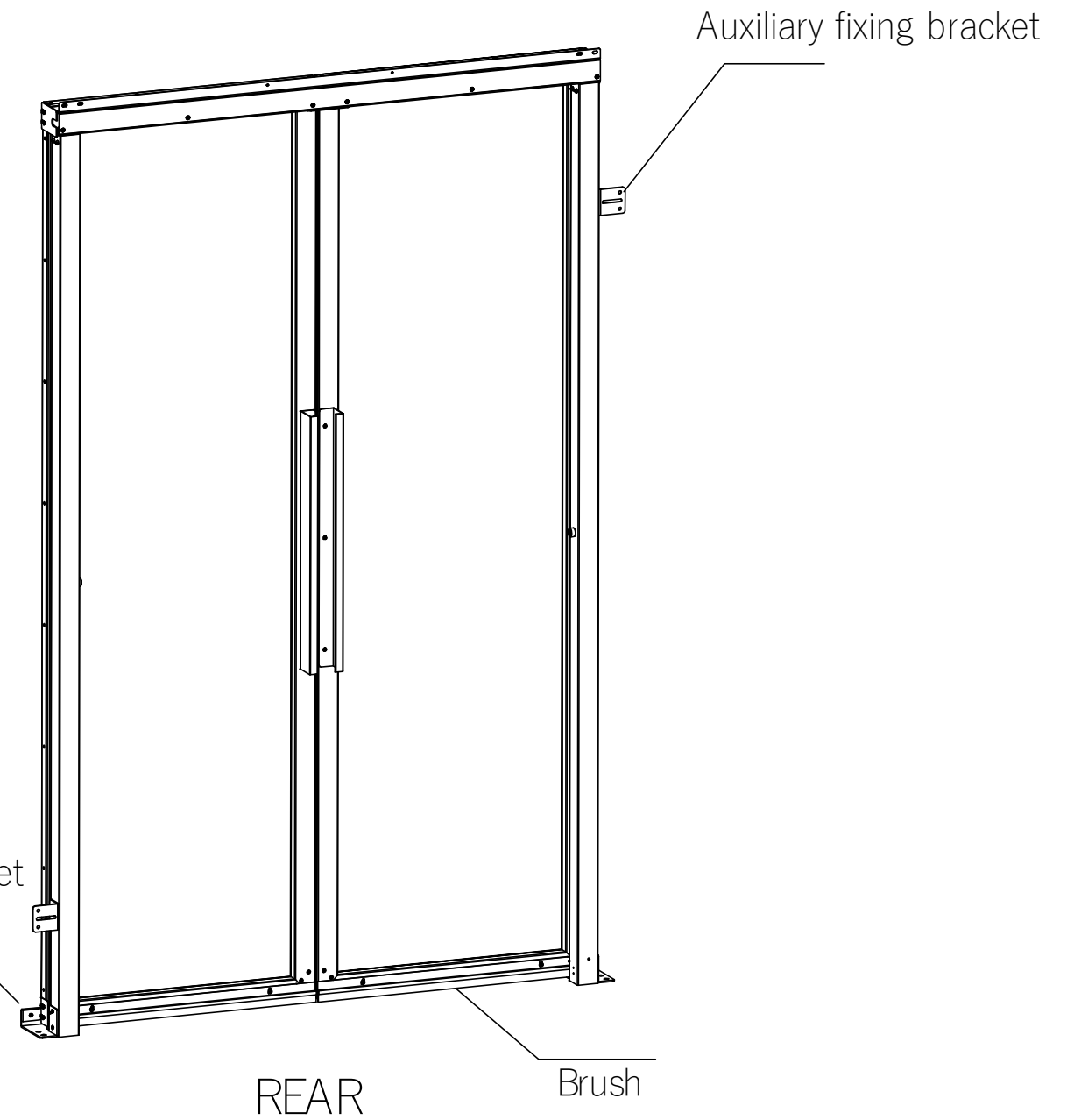

Ground fixing bracket



Notes:

This drawing and its specifications are the property of ENCONNEX and shall not be copied, reproduced, or used in whole or in part, as the basis for the manufacture or sale of items without written permission from ENCONNEX. This drawing is based upon the latest available information and is subject to change without notice.

TOLERANCES LINEAR (mm) X = ± 1 X.X = ± 0.5 X.XX = ± 0.30 X.XXX = ± 0.130 ANGULAR X = 1° X = 0.5° .XX = 0.25°	MATERIAL:	 ENCONNEX 4670 AIRCENTER CIRCLE, RENO, NV 89502	PART NUMBER: ECX-CTMT-S12DS-001
	DESCRIPTION:		DESCRIPTION:
 DEBUR AND BREAK SHARP EDGES/CORNERS AT 0.2mm MAX	DRAWN BY: SAM DING APPROVED BY: R. FAULKNER	ORG DATE: 2020-02-10 REV DATE: 2020-02-10	
UNITS: mm [in]	INTERPRET TO ASME Y14.100	SIZE: B SCALE: N/A	SHEET: 1/2 REV: 1

Notes/Instructions:

1. MATERIAL: N/A
2. FINISH: N/A
3. PART MUST BE SUFFICIENTLY FREE OF BURRS AND SHARP EDGES TO PASS UL 1439 SHARP EDGE TEST.
4. MARK ENCONNEX PART # AND VENDOR I.D. 3MM HIGH WHERE SHOWN. IF PART TOO SMALL BAG OR TAG WITH SAME INFORMATION.
5. 3D CAD AVAILABLE IN ADDITION TO PDF PRINT. SHOULD DISCREPANCY ARISE, CONSULT ENCONNEX ENGINEERING IMMEDIATELY.
6. ALL PARTS TO BE FREE OF DIRT OR GRIME THAT PREVENTS LABEL ADHESION OR ALLOWS TRANSFER ONTO COSMETIC AREAS.
7. MUST BE ROHS COMPLIANT, INCLUDING HARDWARE. IF CONFLICTING SPECIFICATIONS EXIST, CONTACT ENCONNEX ENGINEERING.
8. MARK ENCONNEX PART # AND VENDOR I.D. 3MM HIGH WHERE SHOWN. IF PART TOO SMALL BAG OR TAG WITH SAME INFORMATION.
9. DIMENSIONS IDENTIFIED WITH (XXX) ARE CONSIDERED CRITICAL TO QUALITY (CTQ) DIMENSIONS. THESE DIMENSIONS ARE EXPECTED TO BE MONITORED STATISTICALLY AND DOCUMENTED AS PART OF THE FABRICATION PROCESS.

REV	REV DATE	DESCRIPTION	APPROVAL
-	-	-	-

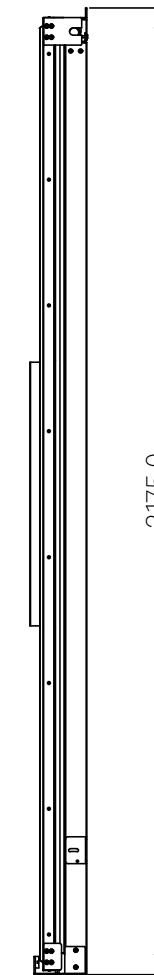
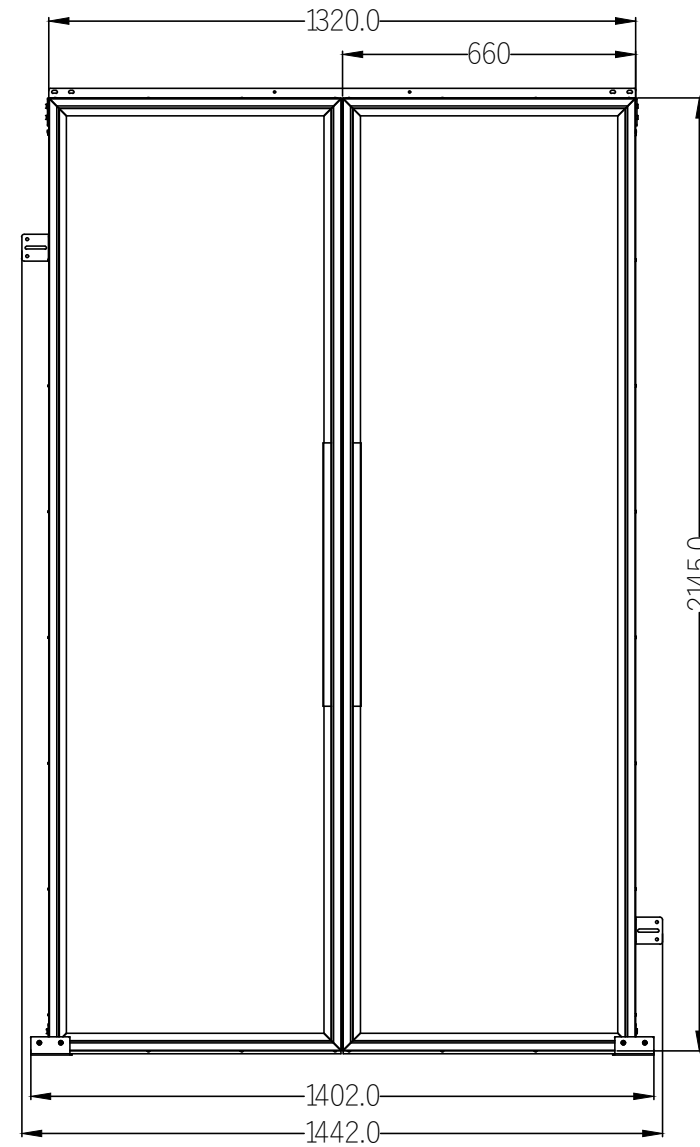
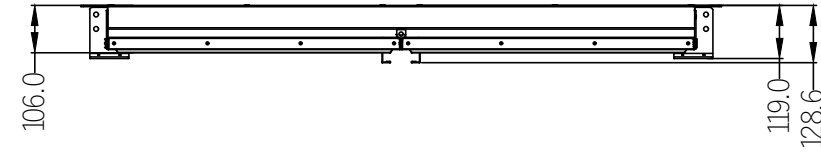

Notes:

This drawing and its specifications are the property of ENCONNEX and shall not be copied, reproduced, or used in whole or in part, as the basis for the manufacture or sale of items without written permission from ENCONNEX. This drawing is based upon the latest available information and is subject to change without notice.

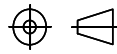
TOLERANCES LINEAR (mm) X = ± 1 X.X = ± 0.5 X.XX = ± 0.30 X.XXX = ± 0.130 ANGULAR X = 1° .X = 0.5° .XX = 0.25°	MATERIAL:	 4670 AIRCENTER CIRCLE, RENO, NV 89502	PART NUMBER: ECX-CTMT-S12DS-001
	DESCRIPTION:		DESCRIPTION:
 DEBUR AND BREAK SHARP EDGES/CORNERS AT 0.2mm MAX	DRAWN BY: SAM DING APPROVED BY: R. FAULKNER	ORG DATE: 2020-02-10 REV DATE: 2020-02-10	
UNITS: mm [in]	INTERPRET TO ASME Y14.100	SIZE: B	SCALE: N/A
		SHEET: 2/2	REV: 1