

Notes/Instructions:

REV	REV DATE	DESCRIPTION	APPROVAL
A	2019-06-19	RELEASE	

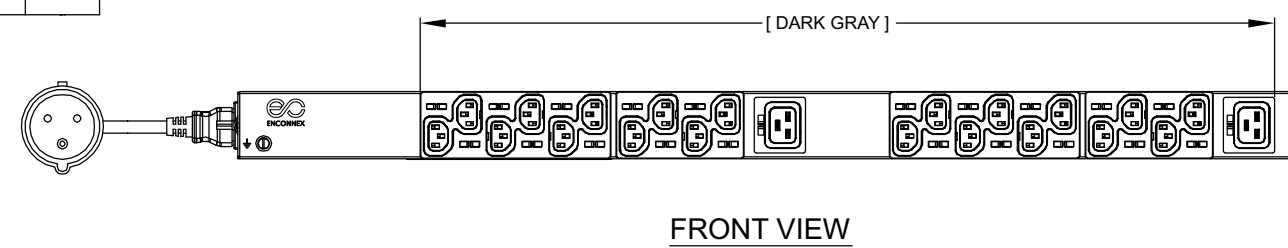
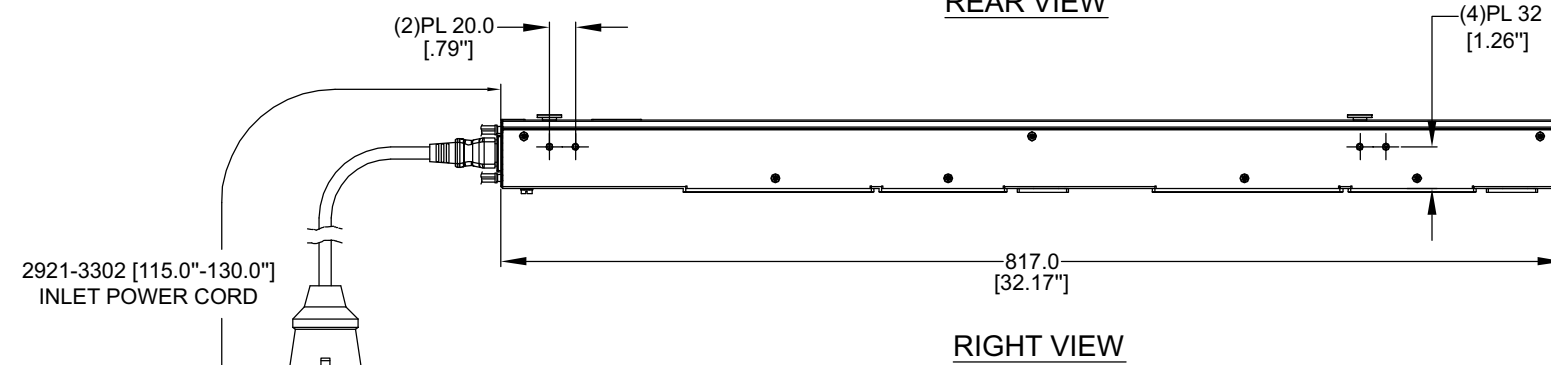
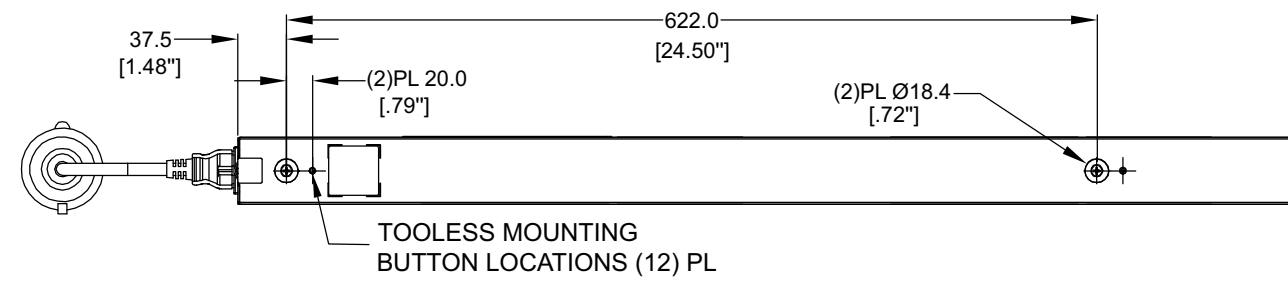
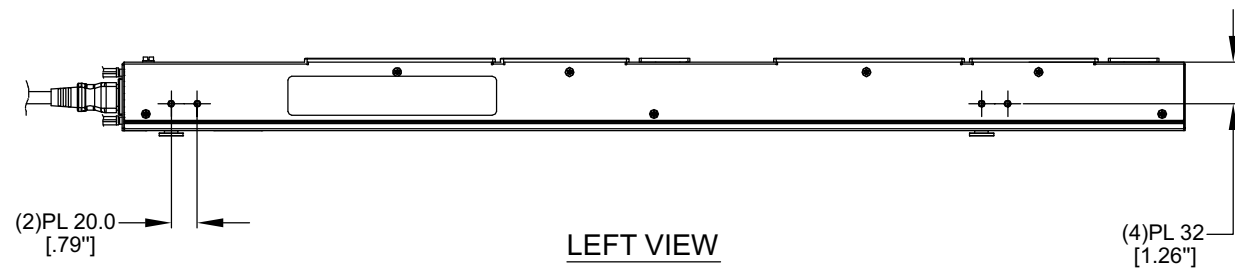

SPECIFICATION:

1. STANDARD:

UNIT TYPE:	BASIC
ORIENTATION:	VERTICAL, HALF
OUTLET QTY&TYPE:	(20) C13, (2) C19
INPUT VOLTAGE:	100-240VAC
INPUT CURRENT:	16A
BREAKER QTY&TYPE:	N/A
INPUT PHASE:	SINGLE-PHASE
RATED POWER:	3.7kVA
INPUT PLUG:	IEC 60309 2P+E 6H 16A
INPUT POWER CORD:	3m [10'], TOP FEED
REGULATORY STANDARD:	RoHS COMPLIANT

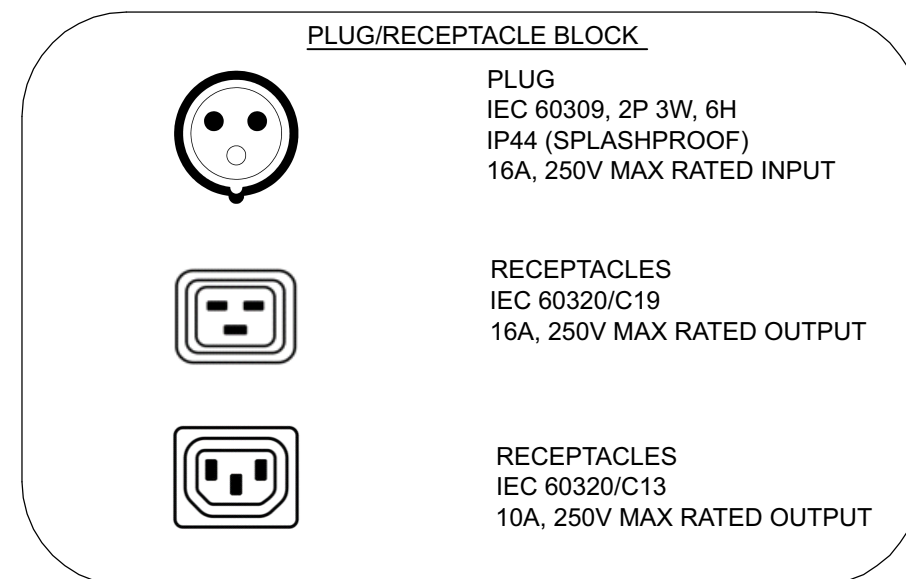
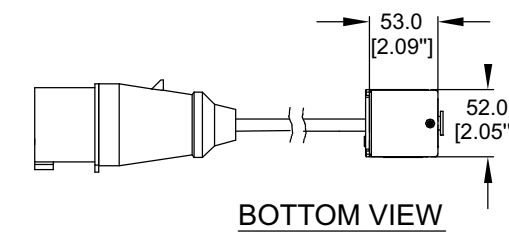

Notes:
This drawing and its specifications are the property of ENCONNEX and shall not be copied, reproduced, or used in whole or in part, as the basis for the manufacture or sale of items without written permission from ENCONNEX. This drawing is based upon the latest available information and is subject to change without notice.

TOLERANCES LINEAR (mm) X = ± 1 XX = ± 0.5 XXX = ± 0.30 XXXX = ± 0.130 ANGULAR X = 1° XX = 0.5° XXX = 0.25°	MATERIAL:	 4670 AIRCENTER CIRCLE, RENO, NV 89502	PART NUMBER: ECX-BV1120020-N
	DESCRIPTION:		DESCRIPTION: 240V/16A Single Phase, 22 outlets, 20 C13, 2 C19, IEC 60309
DEBUR AND BREAK SHARP EDGES/CORNERS AT 0.2mm MAX UNITS: mm [in]	DRAWN BY: Leo Liu APPROVED BY: R. FAULKNER	ORG DATE: 2019-06-19 REV DATE:	INTERPRET TO ASME Y14.100 SIZE: A2 SCALE: 1 : 1 SHEET: 1/2 REV: A

REV	REV DATE	DESCRIPTION	APPROVAL
A	2019-06-19	RELEASE	

Notes/Instructions:

NOTES:
 1. INTERNAL WIRING:
 WIRE TYPE: UL AWM 1015, 12AWG
 LINE 1/R/X COLOR: BROWN
 EARTH GROUND COLOR: GREEN/YELLOW STRIPE
 NEUTRAL WIRE COLOR: BLUE

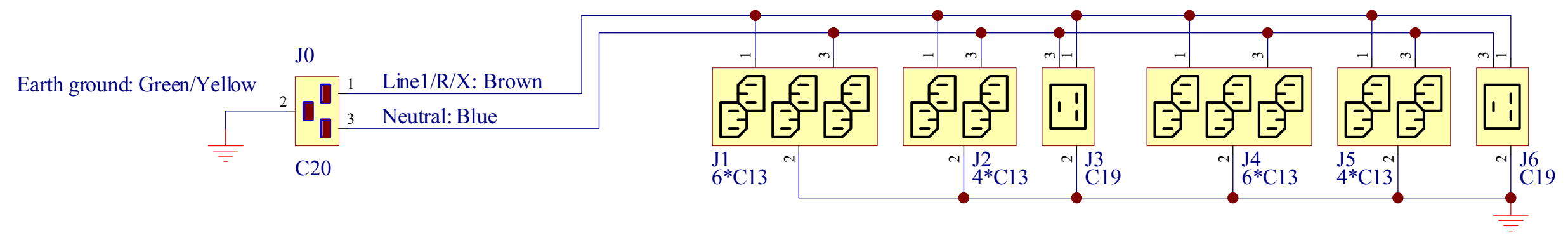

INTERNAL WIRING SCHEMATIC

Notes:
 This drawing and its specifications are the property of ENCONNEX and shall not be copied, reproduced, or used in whole or in part, as the basis for the manufacture or sale of items without written permission from ENCONNEX. This drawing is based upon the latest available information and is subject to change without notice.

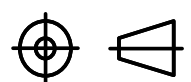
TOLERANCES LINEAR (mm) X = ± 1 X.X = ± 0.5 X.XX = ± 0.30 X.XXX = ± 0.130 ANGULAR X = 1° .X = 0.5° .XX = 0.25°	MATERIAL:	 4670 AIRCENTER CIRCLE, RENO, NV 89502	PART NUMBER: ECX-BV1120020-N
	DESCRIPTION:		DESCRIPTION: Wiring Scheme
 DEBUR AND BREAK SHARP EDGES/CORNERS AT 0.2mm MAX	DRAWN BY: Jing Zhang	ORG DATE: 2019-06-19	
	APPROVED BY: R. FAULKNER	REV DATE:	
UNITS: mm [in]	INTERPRET TO ASME Y14.100	SIZE: A4	SCALE: 1 : 1
		SHEET: 2/2	REV: A