

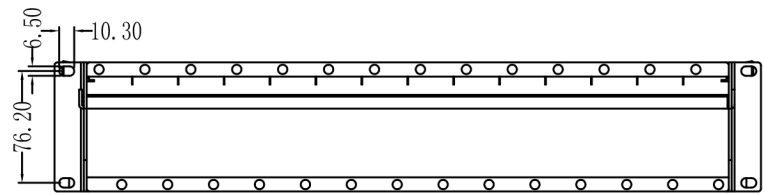

Tolerance			
Length	Super	High	Comm
<3	0.05	0.1	--
3T0<6	0.05	0.1	0.2
6T0<30	0.1	0.2	0.5
30T0<120	0.15	0.3	0.8
120T0<315	0.2	0.5	1.2

Version	Mark	Date	Before	Current
AO				

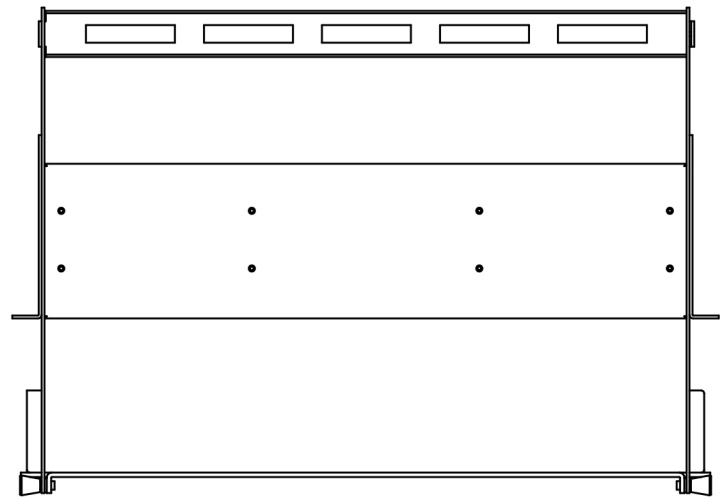
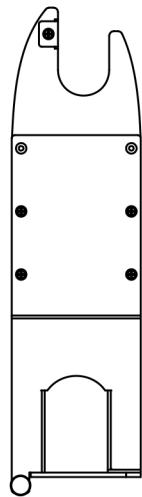
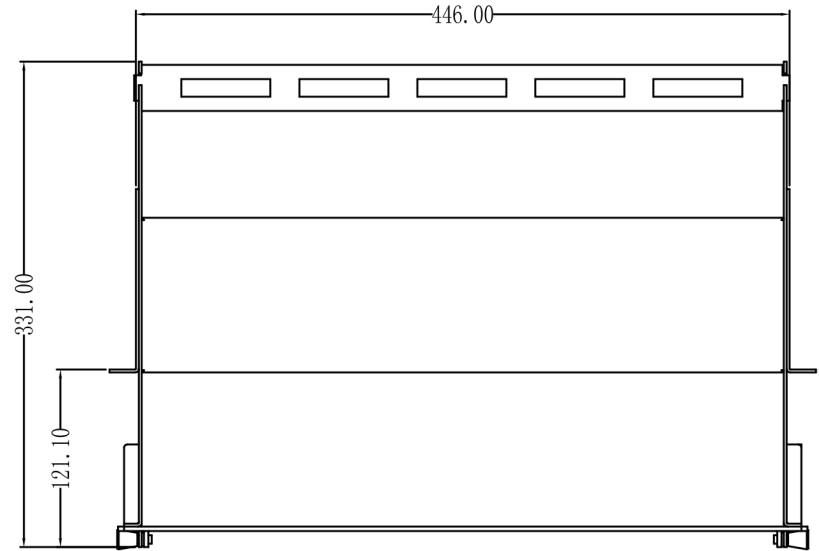
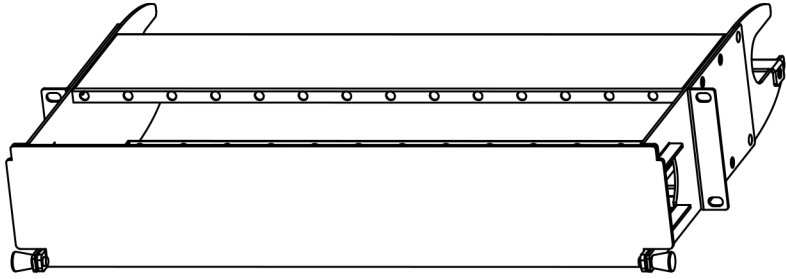
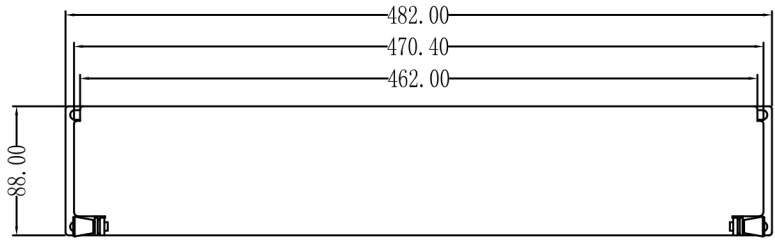

	UNIT	mm	PAGE	1 / 1	MODEL	Patchpanel
	SCALE	0.200	DRAW	---	DRAW NO.	FBK-LFL07-001
	MAT.		CHECK		NAME	2U Patchpanel
	DATE		APPR.		MAT_NO.	FBK-LFL07-001
VIEW		ENCONNEX				