

Notes/Instructions:

REV	REV DATE	DESCRIPTION	APPROVAL
-	-	-	-

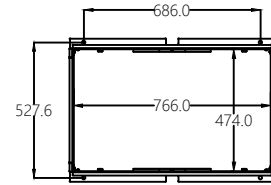

TOP VIEW

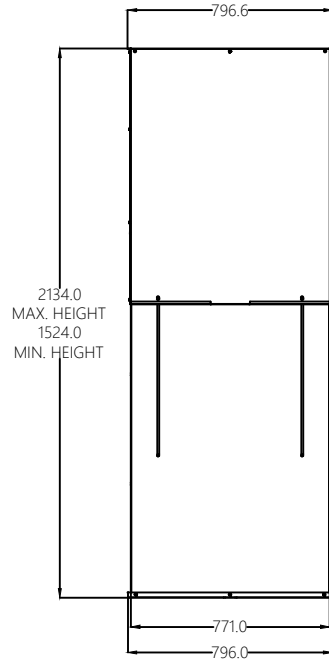

FRONT VIEW

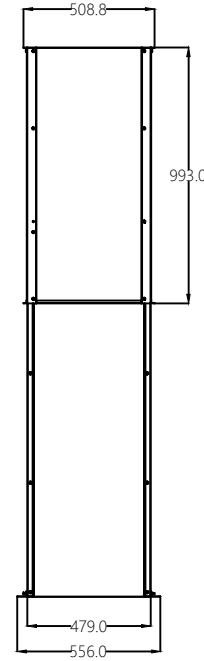

SIDE VIEW

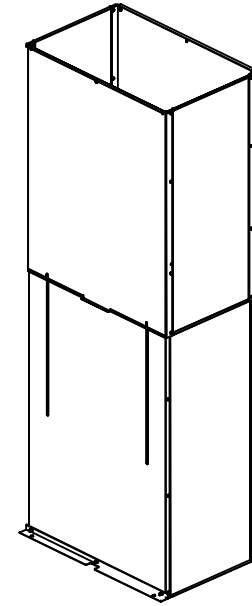

Notes:

This drawing and its specifications are the property of ENCONNEX and shall not be copied, reproduced, or used in whole or in part, as the basis for the manufacture or sale of items without written permission from ENCONNEX. This drawing is based upon the latest available information and is subject to change without notice.

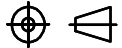
<p>TOLERANCES LINEAR (mm) X = ± 1 X.X = ± 0.5 X.XX = ± 0.30 X.XXX = ± 0.130 ANGULAR X = 1° .X = 0.5° .XX = 0.25°</p>	PRODUCT:	 4670 AIRCENTER CIRCLE, RENO, NV 89502	PART NUMBER: ECX-VED8-15242132
	WEIGHT:		DESCRIPTION: Chimney Width 800 Length 1524-2134 With half roof
	DEBUR AND BREAK SHARP EDGES/CORNERS AT 0.2mm MAX	DRAWN BY: AMY ZHU	ORG DATE: 2019-11-08
	UNITS: mm [in]	INTERPRET TO ASME Y14.100	APPROVED BY: FANCY FAN
		SIZE: A4	SCALE: N/A
		SHEET: 1/2	
		REV: A	

Notes/Instructions:

REV	REV DATE	DESCRIPTION	APPROVAL
-	-	-	-

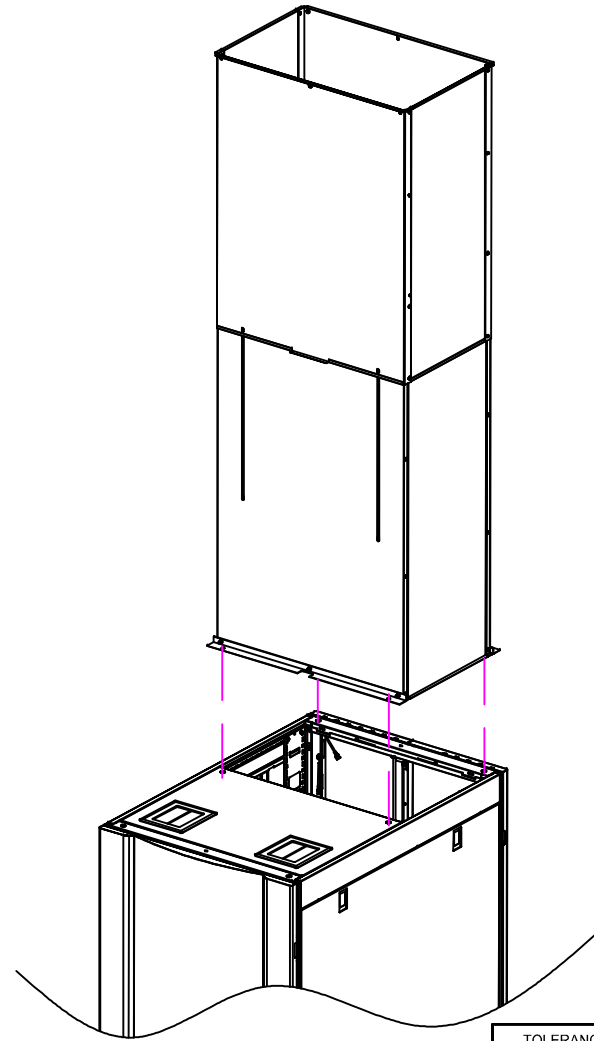

Notes:

This drawing and its specifications are the property of ENCONNEX and shall not be copied, reproduced, or used in whole or in part, as the basis for the manufacture or sale of items without written permission from ENCONNEX. This drawing is based upon the latest available information and is subject to change without notice.

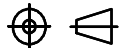
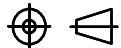
TOLERANCES LINEAR (mm) X = ± 1 X.X = ± 0.5 X.XX = ± 0.30 X.XXX = ± 0.130 ANGULAR X = 1° .X = 0.5° .XX = 0.25°	PRODUCT:	 4670 AIRCENTER CIRCLE, RENO, NV 89502	PART NUMBER: ECX-VED8-15242132
	WEIGHT:		DESCRIPTION: Chimney Width 800 Length 1524-2134 With half roof
 DEBUR AND BREAK SHARP EDGES/CORNERS AT 0.2mm MAX	DRAWN BY: AMY ZHU	ORG DATE: 2019-11-08	
 UNITS: mm [in]	INTERPRET TO ASME Y14.100	APPROVED BY: FANCY FAN	REV DATE: 2019-11-08
		SIZE: A4	SCALE: N/A
			SHEET: 2/2
			REV: A